

# 4" x 5,65" Matte Box 19 (MB-19)



CONFIGURATION OVERVIEW – 7.6.0 / 2010.07

© 2010 Arnold & Richter Cine Technik GmbH & Co. Betriebs KG. All rights reserved. This material is provided "as is" for information purposes only without any warranty. ARRI assumes no responsibility with regard to the performance or use of the products or typographical errors or inaccuracies of given information. Product specifications are subject to change without notice. For a full listing of all available components consult the price list.

## Light Protection

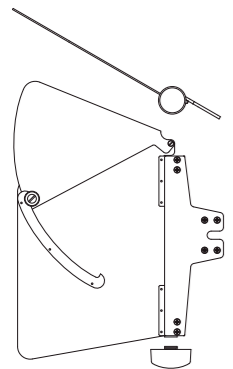

**Light Shield Set**  
(top+left+right), K0.59995.0  
(top/bottom flags only), K2.66019.0  
(side flags pair only), K2.47106.0

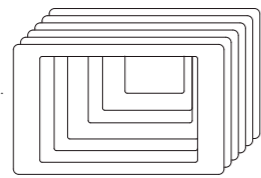

**Set of masks**  
18 – 180 mm (35 mm lenses)  
K2.47109.0  
9.5 – 180 mm (16 mm lenses)  
K2.47108.0

## Carriers & Filter Stages

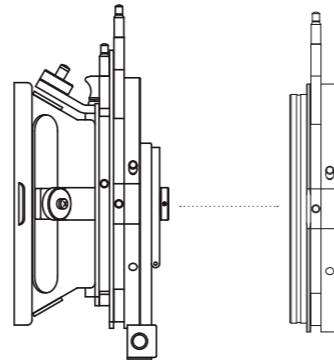

**MB-19, without rod adapter for lightweight support LWS-6**  
K2.47099.0  
Set includes:  
Filter Stage for two filters, K2.47100.0  
two filter holders 4" x 5.65"  
French Flag holder

**Supplementary filter stage**  
K2.47100.0  
for one filter 4 x 5.65" and one round filter 138 mm

## Accessories



**French flag holder**  
K5.48613.0  
(included in MB-19 Sets)



**Case for MB-19**  
K2.47116.0  
with variable deviders

## F4 Filter frames

**4" x 5,65" Filter frame horizontal**  
K2.47669.0

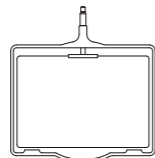

**4" x 5,65" Filter frame vertical spare**  
K4.47493.0

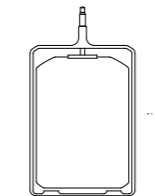

**4" x 4" Filter frame horizontal**  
K2.47104.0

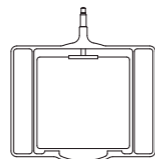

**4" x 4" Filter frame**  
K2.47105.0

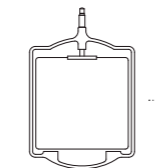

**Adapter for 19 mm Rods**  
K2.47101.0

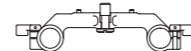

**Adapter for 15 mm Rods**  
K2.47102.0

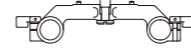

## R2 Filter Rings



**Adapter ring R2-R3**  
allows use of R3 filter rings  
K2.47115.0



**Large Diameter Wide-Angle Light Trap Rings** (not for clamp on ring) reducing filter diameter from 138 mm to listed diameter  
K2.65069.0 (ø 117 mm)  
K2.65070.0 (ø 120 mm)  
K2.65123.0 (ø 121 mm)  
K2.65071.0 (ø 128 mm)\*  
\*not for Fujinon 3 x 5 HAe Super Zoom)  
K2.65090.0 (ø 128 mm)\*  
\*for Fujinon 3 x 5 HAe Super Zoom)  
K2.65072.0 (ø 130 mm)  
K2.65073.0 (ø 132 mm)



**Adapter Ring**  
reduces filter diameter from 138 mm to 114 mm (4½")  
K2.49099.0

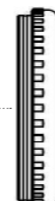

**138 mm filter ring**  
K2.52204.0 (ø 114 mm)



**138 mm filter ring**  
K2.47190.0 (ø 114 mm)  
(wide angle; internal focus lenses only)

\* discontinued items, only as long as stock is available

## R3 Filter Rings

**CAUTION: CAN VIGNETTE. PLEASE CONTACT ARRI.**



**4½" (114 mm) filter ring**  
K2.49109.0 (ø 87 mm)



**Reduction ring (R6)**  
K2.47226.0 (ø 80 mm)



**4½" (114 mm) filter ring**  
K2.49102.0 (ø 95 mm)



**Reflex prevention ring**  
K2.32911.0 (ø 125 mm)



**4½" (114 mm) filter ring**  
K2.52205.0 (ø 114 mm)

## R4, R5 Reduction Rings

**Video Connection Rings**



**Reduction rings (R4 | 114 mm)**  
K2.65055.0 (ø 96 mm)  
K2.65044.0 (ø 98 mm)  
K2.65046.0 (ø 100 mm)  
K2.66066.0 (ø 103 mm)  
K2.52195.0 (ø 104 mm)  
K2.65096.0 (ø 105 mm)  
K2.65045.0 (ø 110 mm)



**Reduction rings (R5 | 100 mm)**  
K2.65043.0 (ø 80 mm)  
K2.65038.0 (ø 85 mm)  
K2.65039.0 (ø 86 mm)  
K2.47225.0 (ø 87 mm)  
K2.65040.0 (ø 90 mm)  
K2.65054.0 (ø 92 mm)  
K2.47224.0 (ø 95 mm)  
K2.65029.0 (ø 95 mm WA)\*  
(WA =wide angle)

Note: Only for wide angle lenses with cutouts (4.9 mm and below)  
For lenses larger than 4.9 mm use K2.47224.0

ø = diameter of connection ring to lens

### MB 19 technical data:

Min focal length 35 mm lenses:	14 mm
Min focal length 16 mm lenses:	6 mm
Max number of 4 x 5.65 filters:	three 4 x 5.65 filters
Max number of 138 mm round filters:	one 138 mm round filter
Max number of 4½" round filters:	one 4½" round filter
Dimensions:	372 x 260 x 155 mm
Weight:	approx. 800 g (1.8 lbs)

### Note: For Canon 11 x 4.7

and Fujinon 13 x 4.5  
use MB-20 + K2.65029.0 (-VA95)